

September-October 2000



MAI
Magazine



YOU'LL DIG THE
NEW LEGO®
DINOSAURS
AS THE
ADVENTURERS
EXPLORE
DINO ISLAND!



GAIL, JOHNNY, LOOK!
IT'S A T-REX AND A
STEGOSAURUS. QUICK TAKE
A PICTURE!!

LUHHH. I DON'T
HAVE ANY MORE
FILM LEFT.

DR. LIGHTNING..
ARE THESE SOMETHING FROM
THE DINOSAUR FAMILY!??

NEW

DANGER on Dino Island



A band of dinosaurs lives on a mysterious lost island. They have survived for millions of years without being discovered - until now. While chasing Sam Sinister's plane, Johnny Thunder crashed landed his Island Hopper on Dino Island.

The Adventurers just want to study these amazing animals at their research compound. But Sam Sinister wants to capture the creatures and create his own dino theme park!



Johnny Thunder

Johnny has battled the sinister forces of Sam Sinister all over the world. They raced to dig the mummy's treasure in the desert and to find lost gold in the jungle. Saving dinosaurs from Sam Sinister may be his toughest adventure yet!



Dr. Charles Lightning

Dr. Lightning is Johnny's uncle, and taught Johnny everything he knows. But sometimes he forgets that the dinosaurs are real and not stuffed. One time, he almost got stomped on.



Sam Sinister (aka Baron von Barron)

Sam's hobby is stealing rare treasures for his own collection. The only person that has ever stopped him is Johnny Thunder. Sam says that if Johnny gets in his way he will use him as bait in a T-Rex trap.



Mike

Johnny Thunder rescued Mike on one of his adventures. Mike never had a dog or a cat, so he wants to keep a baby T-Rex as a pet.



Gail Storm

Gail records all of the Adventurers' adventures and has tangled with Alexia Sinister before.



Alexia Sinister

Sam finds the treasure to steal, but it is his sister Alexia who comes up with the plans. Alexia keeps trying to get Johnny Thunder to work for the bad guys.



Mr. Cunningham

Mr. Cunningham is very sneaky. He changes his disguise almost every week. Mr. C is Sam Sinister's toughest tough guy. He's so tough, he wants to wrestle a T-Rex.

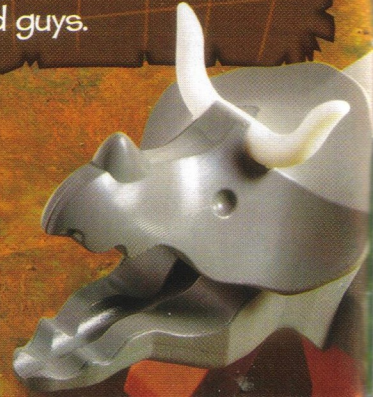

the Adventures of the LEGO Maniac

DOUBLE TROUBLE ON DINO ISLAND

IT'S TIME TO GET THIS BAD BOY BACK TO DINO ISLAND.

FOG ROLLS IN AT DINO RESEARCH CENTER. DR. LIGHTNING FINISHES STUDYING A STEGOSAURUS. LET'S SEE WHAT HAPPENS...SAM SINISTER...DEADLY TRAPS...A T-REX ON THE LOOSE. **WILL JOHNNY SAVE THE DAY!?!**



Johnny Thunder loads the stegosaurus onto a ship.

THIS BEAST WEIGHS A TON.

ACTUALLY, STEGGY WEIGHS 2.5 TONS.

But wait, the Adventurers are being followed by one of Sam Sinister's men.

I HOPE JOHNNY CAN FLY IN THIS FOG.

DON'T WORRY. MIKE WILL HELP JOHNNY.

THEY'LL HAVE A SURPRISE WHEN THEY GET TO DINO ISLAND.

CUNNINGHAM TO SINISTER....JOHNNY'S MAKING A CRASH LANDING.... OVER.

I CAN'T SEE A THING, MIKE....HANG ON, WE'RE GOING DOWN!

ME NEITHER, JOHNNY. LOOK OUT FOR THAT PTEROSAUR!

The fog gets thicker. Will Johnny and Mike survive a crash landing?

WOOON

WOOON

CRRASH

Alexia and Sam watch the plane crash from their hiding spot.



GREAT LANDING, JOHNNY!

WOW, GREAT LANDING! OH, OH, SAM AND ALEXIA ARE UP TO SOMETHING! THERE'S TROUBLE.

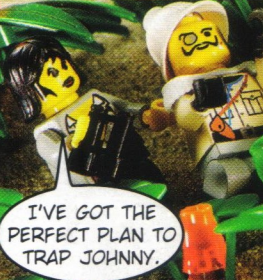

I'VE GOT THE PERFECT PLAN TO TRAP JOHNNY.

HA! HA! JOHNNY WILL LEAD US RIGHT TO THE T-REX.

OK, MIKE LET'S GO LOOK FOR THE T-REX



WITH YOU WEARING GAIL'S HAT, THUNDER IS DINO BAIT

HE'LL BE SURE TO FALL FOR MY CLEVER DISGUISE.



HEY LOOK! A BABY T-REX!

BY THE LOOK OF THESE TRACKS HIS MOM'S NOT FAR AWAY.



THAT SOUNDS LIKE GAIL. COME ON, MIKE!

AHHHH

THAT'S RIGHT, THUNDER. YOU FELL INTO OUR TRAP!

HELP ME, JOHNNY!

HEY, YOU'RE NOT GAIL!

RAHH



THINGS DON'T LOOK TOO GOOD, AND THEY GET WORSE. DON'T LOOK!



DON'T COUNT ON IT, SINISTER. HELP IS COMING RIGHT NOW.

BY THUNDER, THUNDER. THIS TIME YOU WON'T ESCAPE.

ROARRR

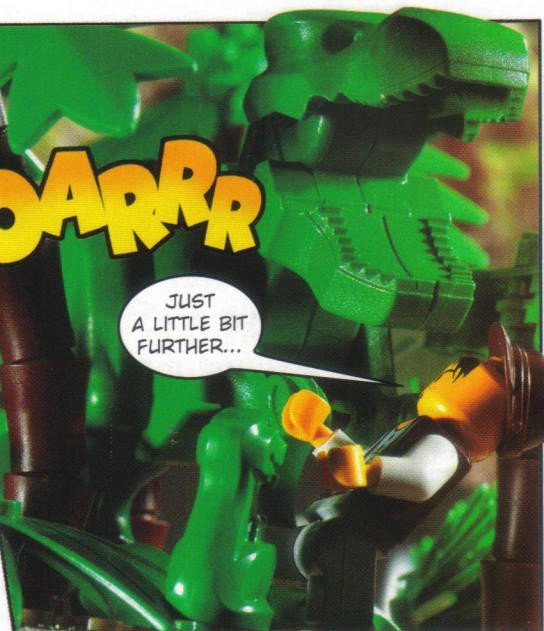

JUST A LITTLE BIT FURTHER...



HI, JOHNNY. I FOUND THE T-REX YOU WERE TRACKING!



HI, UH YOUR BABY WENT THAT WAY.

CUT CUT

YUCK T-REX BREATH.

GRRRRR



SAM, WAIT FOR ME!



SAM, LOOK OUT FOR THE...

OH NO, WE JUST TRIPPED OUR OWN TRAP!



MA-MA.



CAUGHT IN YOUR OWN TRAP. I SHOULD LEAVE YOU HERE FOR A FEW MILLION YEARS.

GOOD JOB JOHNNY!

THUNDER, YOU WOULDN'T!

THE END?

Back in the day...

Dinosaurs were the biggest creatures to roam the earth for over 165 million years. Join Johnny Thunder and the Adventurers for a tour through prehistoric time!



Steady Stegosaurus

A Stegosaurus was slow. Its brain was the size of a golf ball weighing only 2 ounces. The average human brain weighs about 3 pounds.



Factoid: Scientists think the rows of plates along a Stegosaurus's neck and back acted like solar panels that warmed the dinosaur's blood.



This dinosaur's legs were built to support its 2-ton body, not for running. But that didn't mean it was an easy dinner for a predator. One swipe of its spiked tail could send a T-Rex limping away with a sore leg.

Don't mess with a T-Rex!

The fiercest dinosaur on Dino Island is the Tyrannosaurus Rex. The largest and most complete T-Rex skeleton was found in the Badlands area of South Dakota by fossil hunter Sue Hendrickson in 1990. The skeleton, also called Sue, measures 42 feet long and stands 13 feet tall at the hips. Sue's jaws operate like a nutcracker filled with foot-long teeth. A T-Rex had excellent sight and hearing, but its best sense was smell. It could smell dinner a long way off.

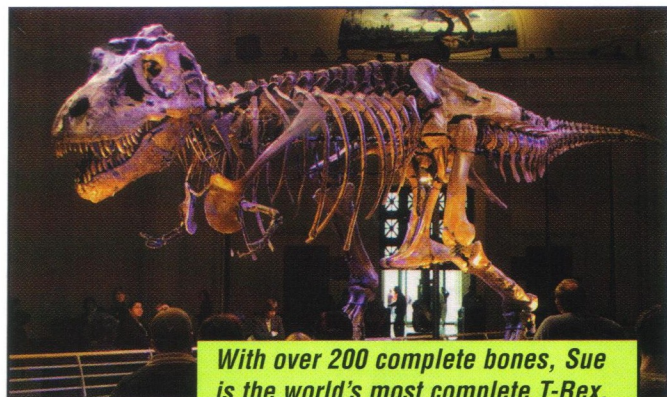

With over 200 complete bones, Sue is the world's most complete T-Rex.

T-Rex may have ruled North America, but it is no longer the world's biggest and baddest dinosaur. Recently, scientists discovered a meat-eater in Argentina called Gigantosaurus. It weighed 3 tons more than T-Rex and had thin, flat teeth. In central Africa, Suchomimus Tenerensis was found in 1998. It was as large as a T-Rex, and had a pointy crocodile-like jaw filled with 100 teeth. It also had 16-inch, razor-sharp claws.

5987 Dino Research Compound





Catch a ride on a Pterodactyl!

By studying fossils, scientists discovered that birds are related to dinosaurs. But the flying creature on Dino Island is not a bird or a dinosaur. It's a flying reptile called a Pterodactyl.

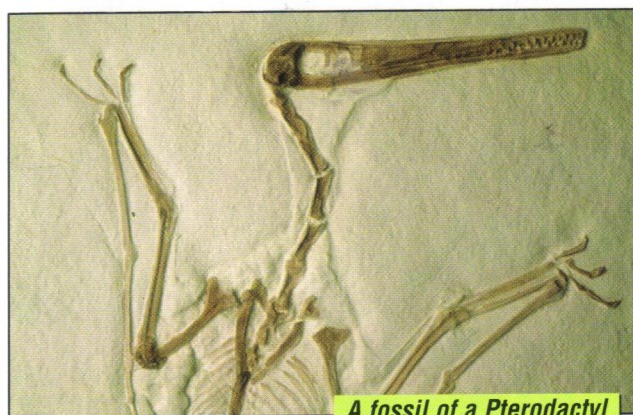

A fossil of a Pterodactyl

The Pterodactyl's wings were like leather, and when flapping, were 25 feet across. When it wasn't building a nest on a rock ledge, it would fly down to the water and scoop fish out with its big beak.

Watch out for spikey Triceratops!

The Triceratops was a fierce looking dinosaur. The three sharp horns on its head could be as long as 4 feet! Triceratops weighed about 7 tons, was as tall as an elephant and was 25 feet long. Its head alone was 7 feet long, one-fourth of its total length. Triceratops ate plants and used its beak-like mouth to snap off tree branches.



Factoid:
A Triceratops's skull alone could weigh one ton.



Amazing Discoveries!

Scientists like Dr. Lightning are finding out more about dinosaurs all the time. In the past 30 years, the number of dino species has doubled. Dinosaur fossils can be found all over the world, even in Antarctica. One of the best places to find fossils is the western United States. That's where T-Rex, stegosaurus, triceratops, and many other dinosaur fossils have been discovered.

Just think of how many more dinosaurs will be discovered by future scientists!

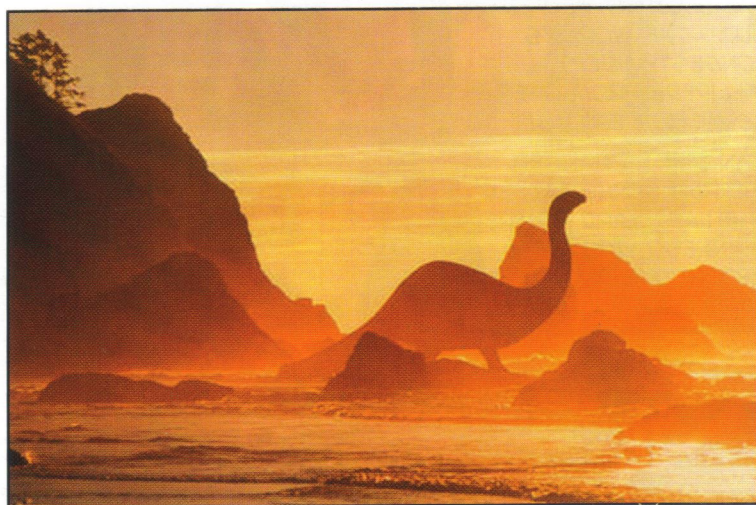



LEGO Maniacs around North America gather for the 1st Ever LEGO Maniac Kidvention!

LEGOLAND CALIFORNIA

LEGOLAND California hosted the first ever national LEGO Maniac Kidvention from July 8th-16th, 2000. Club members and their families had a blast meeting other Club members from around the U.S. and Canada, getting sneak previews, visiting the all-new LEGO Clubhouse, and building the World's longest LEGO Millipede!



THE FIRST 1,000 LEGO MANIACS AT KIDVENTION RECEIVED SPECIAL LEGO MANIAC SUNGLASSES.



VISIT WWW.LEGO.COM FOR MORE PHOTOS!

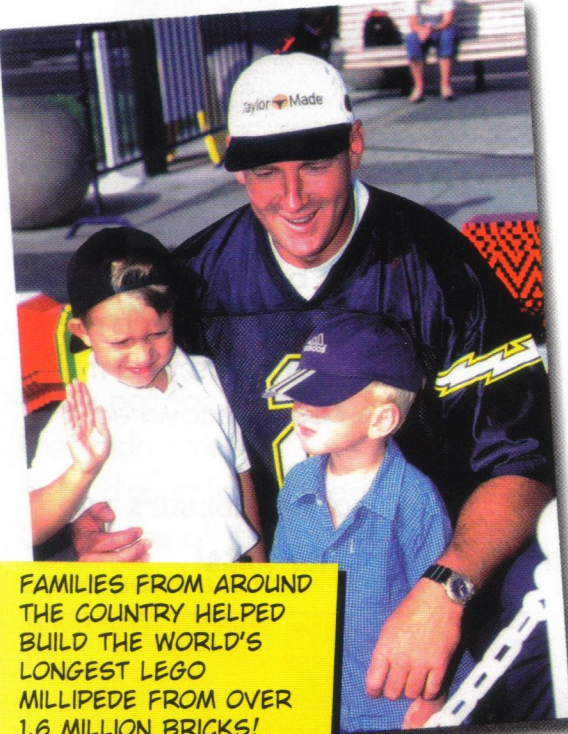

FAMILIES FROM AROUND THE COUNTRY HELPED BUILD THE WORLD'S LONGEST LEGO MILLIPEDE FROM OVER 1.6 MILLION BRICKS!
SAN DIEGO CHARGER DARREN BENNET ADDED THE LAST YARD TO THE GUINNESS WORLD RECORD BREAKING 667 YARD LONG MILLIPEDE!



AT KIDVENTION, CLUB MEMBERS GOT A HANDS-ON SNEAK PREVIEW OF THE LEGO STUDIOS STEVEN SPIELBERG MOVIE MAKING SET!



TWO-TIME ALL-PRO AND LEGO FAN DARRELL RUSSELL OF THE OAKLAND RAIDERS BUILDS A MILLIPEDE SECTION.

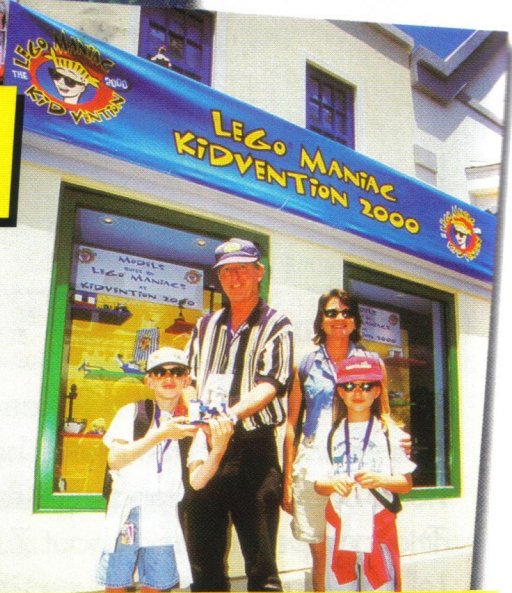

KIDVENTION ALSO MARKED THE GRAND OPENING OF THE LEGO MANIAC CLUBHOUSE! AT THE CLUBHOUSE, MEMBERS CAN BUILD A MODEL FOR THE CLUBHOUSE WINDOW, MEET LEGOLAND MODEL DESIGNERS, SEE THE WALL OF FAME, AND MORE!

**SNEAK
PREVIEW**

Create Your Own LEGO® Movies With the Steven Spielberg Movie Maker Set!

Coming in
November!

Starting this November, the power to make movies will be in your command. Think of a cool story, build a movie set, plug in the PC Movie Camera and you're ready to roll! With the special movie editing software, you can create special effects, add sounds and background music and edit your movie to be just right! For a real world premiere, e-mail it to all your friends!



Movie editing software is easy enough to edit your first movie in just 20 minutes!

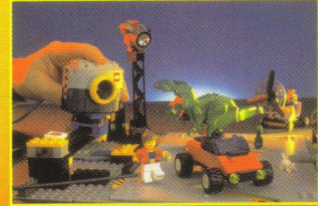

Attach camera to camera sled for steady close-up shots.



FOR MORE INFORMATION AND SAMPLE MOVIE CLIPS, GO TO WWW.LEGO.COM/STUDIOS



TURBO POWERED ACTION!



The ultimate drag race is on!

Chip races the flaming dragster down the runway, he's in the lead - but watch out, here comes Barney in the turbo powered Speed Dragster.

Who will be the one to fly across the finish line and raise the flags of victory?



Hit the finish line and both flags spring up.

I'LL BEAT YOU NEXT TIME BARNEY!



Pull-back into the launch gates. Push the trigger and watch it fly!



maniac madness

"My Magnificent Jet"
Sean Turner, age 9
of New York



HEY KIDS! Send a photo of you and your model to:

**MANIAC Madness
LEGO Club
P.O.Box 1308
Enfield, Ct. 06083-1308**

Remember to include your name, address, age and name of your model. Pictures will not be returned, so take an extra photo for yourself.

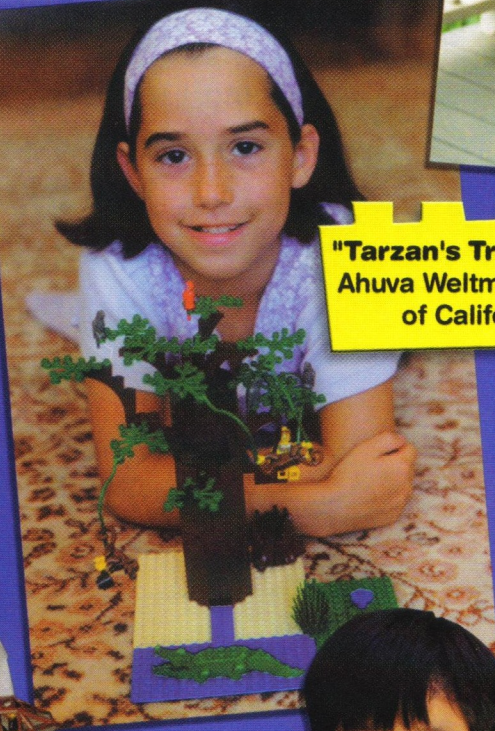

"Tarzan's Treehouse"
Ahuva Weltman, age 9
of California

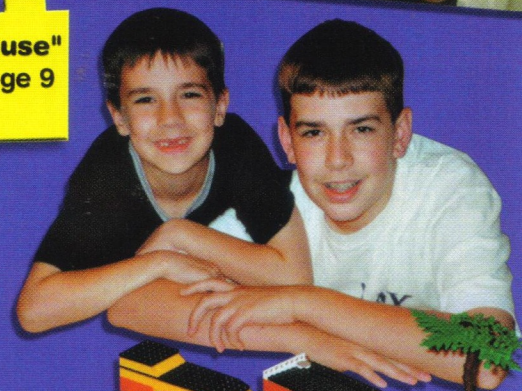

"Gone Camping"
Will Gaylord, age 8
and Ron Gaylord, age 13
of New York

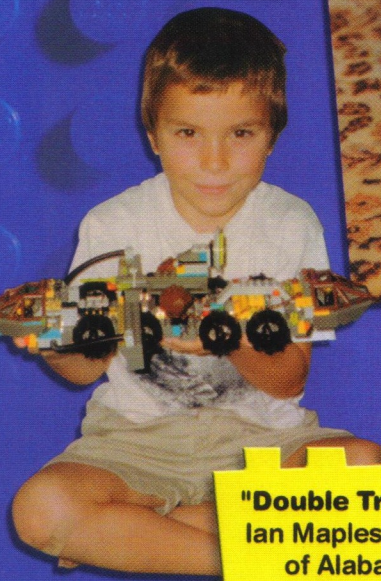

"Double Trouble"
Ian Maples, age 7
of Alabama



"X-P Wraith"
Shanley Wang, age 11
of North Carolina



"Cape Hatteras Lighthouse"
Karl Winnekins, age 6
of Minnesota

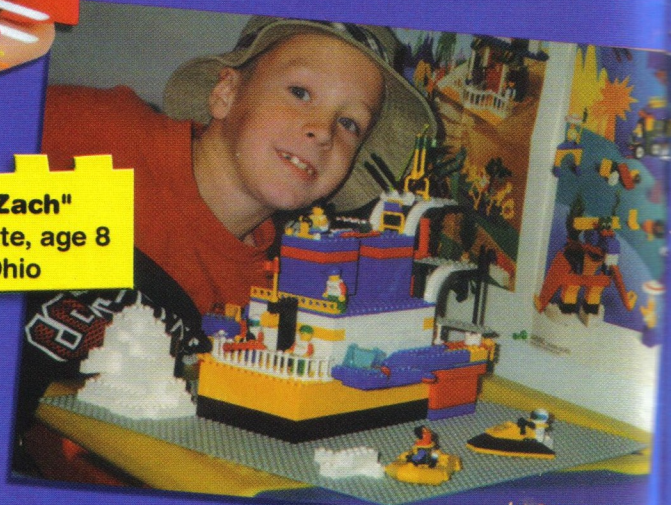

"S.S. Zach"
Zach Klatte, age 8
of Ohio

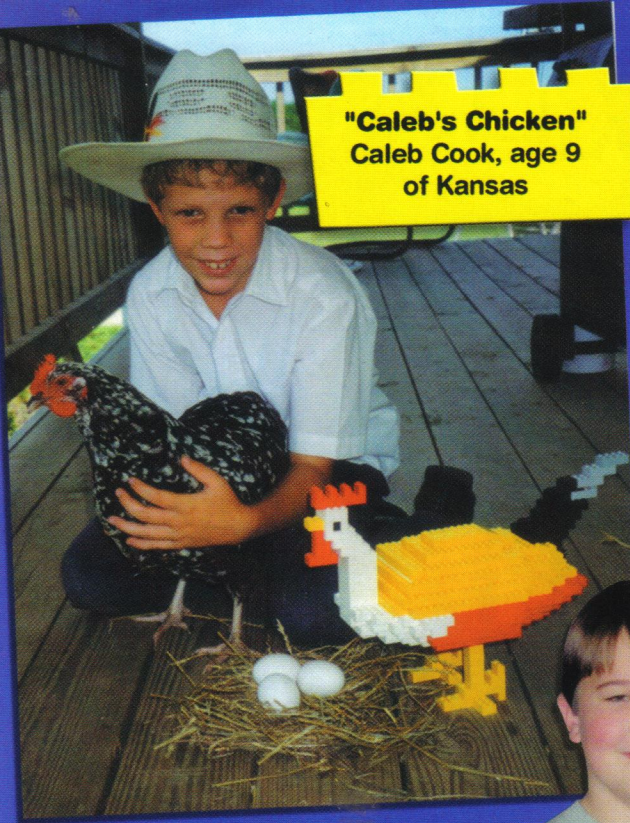

"Caleb's Chicken"
Caleb Cook, age 9
of Kansas

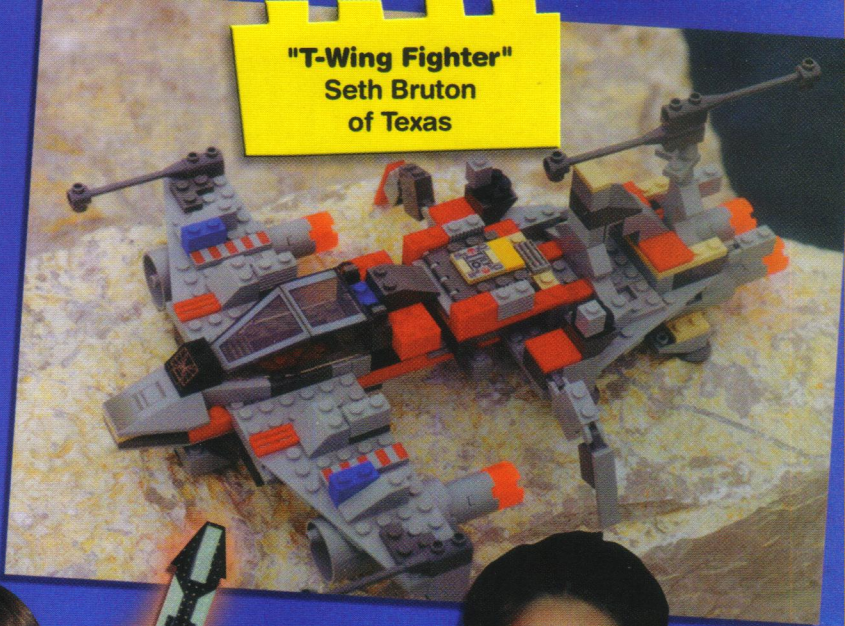

"T-Wing Fighter"
Seth Bruton
of Texas

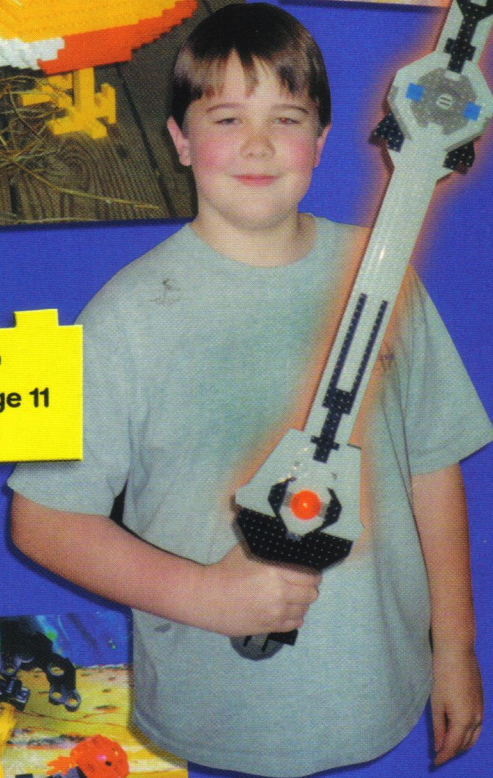

"Excalibur"
Bryan Jones, age 11
of Georgia

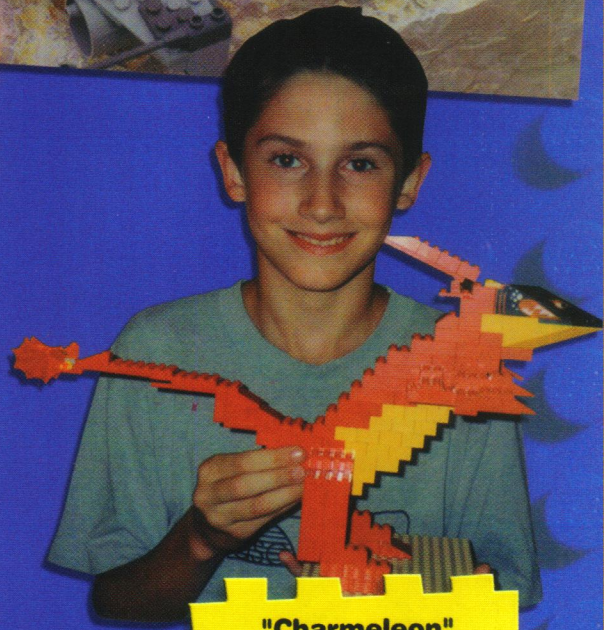

"Charmeleon"
James O'Shea
of Montana



"Brick Street Boys"
Nicole Stepneski, age 12
and Bryan Stepneski, age 9
of New Jersey



"Rocket"
Jonathan Stein, age 10
of California

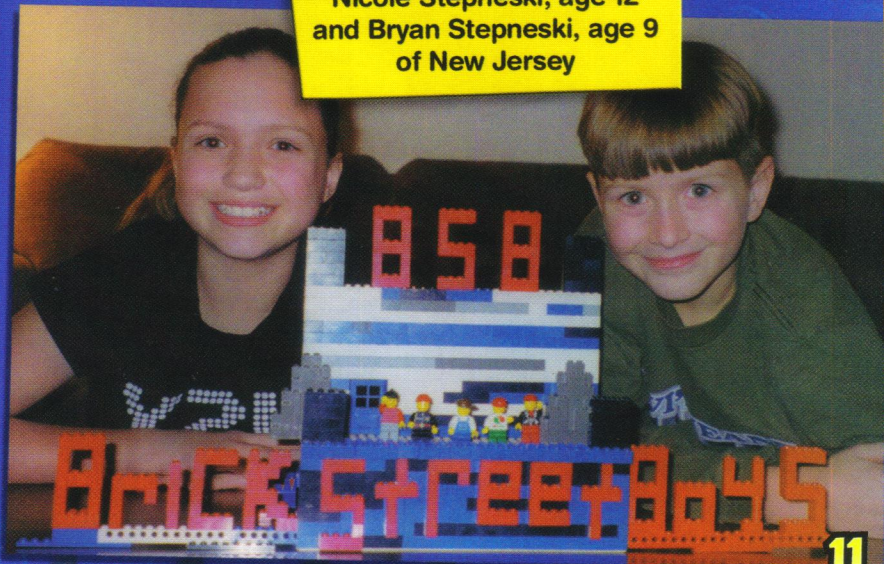

TRAP THE T-REX GAME

A T-Rex has escaped from the 5987 Dino Research Compound. You and the other dino hunters must race after the trampling T-Rex. The first player to trap the T-Rex wins the game. To play, dig out your favorite Adventurers mini figures and a LEGO® brick. Players roll the brick to move their figures around the board. Follow the directions on any space you land on. Happy hunting!



START!



GET BACK HERE REX!

5987
Dino Research
Compound

Drive
Johnny's car,
move ahead
2

THAT'S
NOT A
T-REX!

5955
All Terrain
Trapper

Cross
stinky swamp,
move back
2

Dig a
dino trap,
move ahead
2

K5903
Dino Expedition



5935
Island Hopper

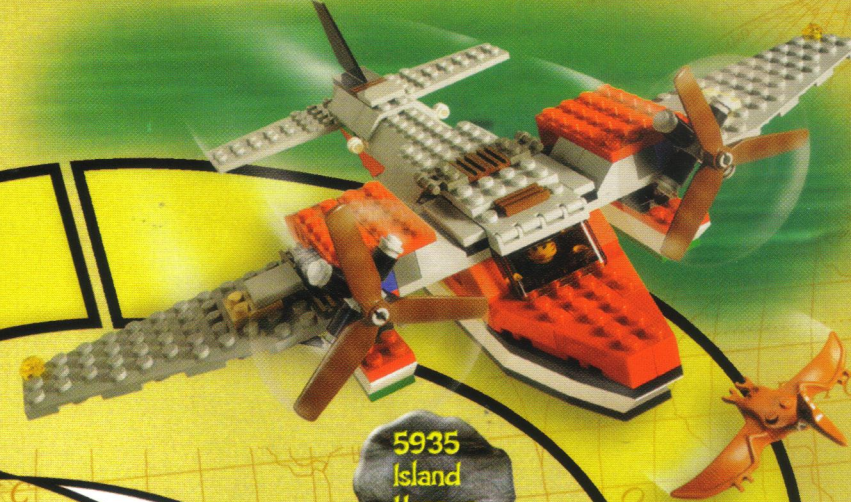

Ride glider, skip ahead



5921
Research Glider

Find T-Rex track, move ahead 3

5920
Island Racer

Step in dino doo, move back 2

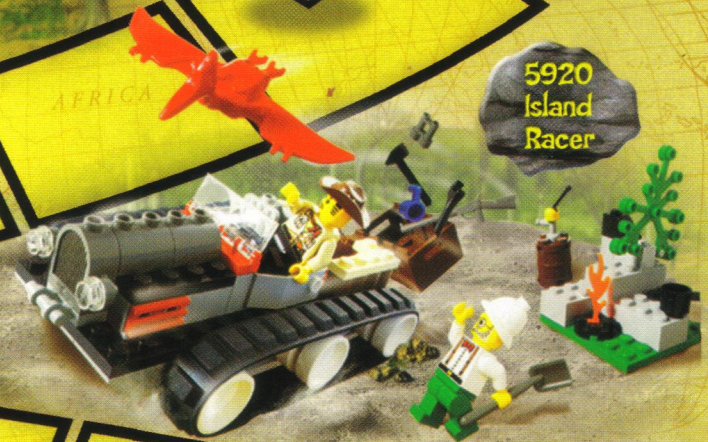

5975
T-Rex Transport

Lose T-Rex track, move back 1

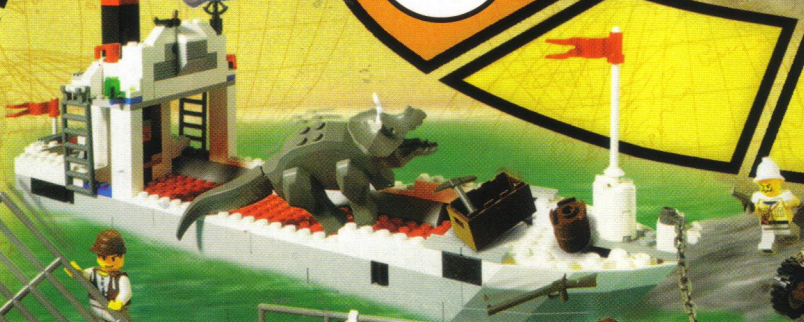

T-Rex breaks free, move back 2



GOT YA REX!



YOU WIN!

Sonic Blaster Buggy

Your original model could be featured in LEGO® Mania™ Magazine. Send a photo of your model to:

LEGO Club
 "You Can Build This..."
 P.O. Box 1308
 Enfield, CT 06083-1308

Club members featured will receive a free LEGO set of their choice (up to \$100 value).



Club member *Simon Bearse*, age 5 of Massachusetts, inspired our model designers to build the *Sonic Blaster Buggy*.

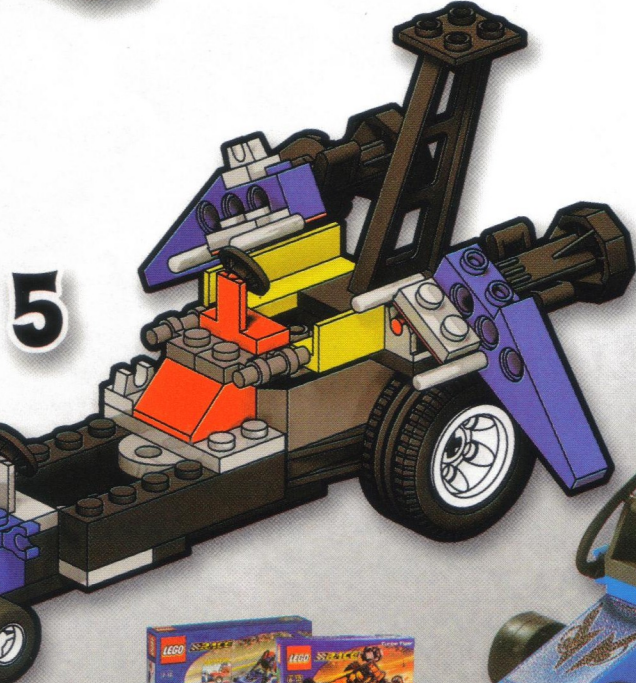
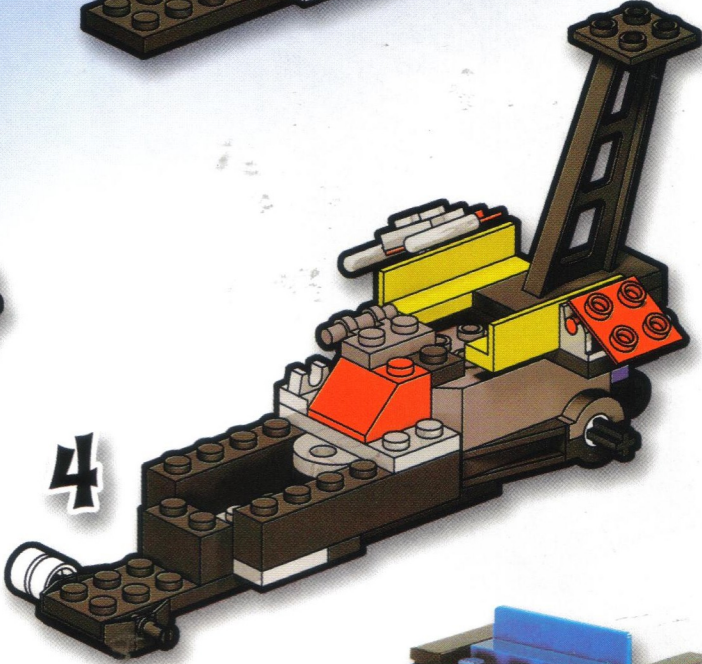
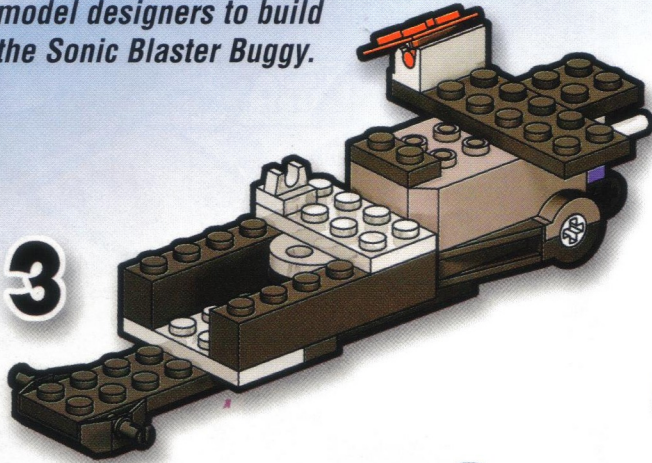
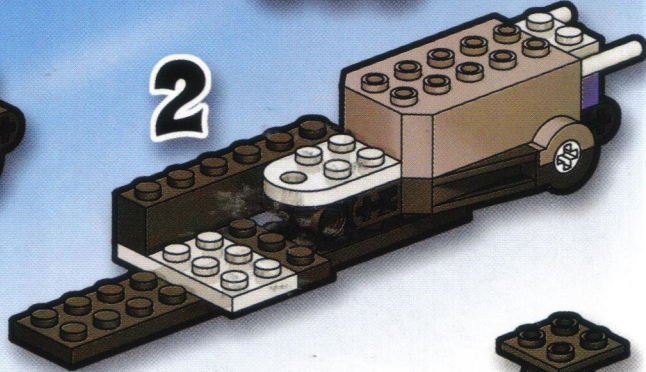
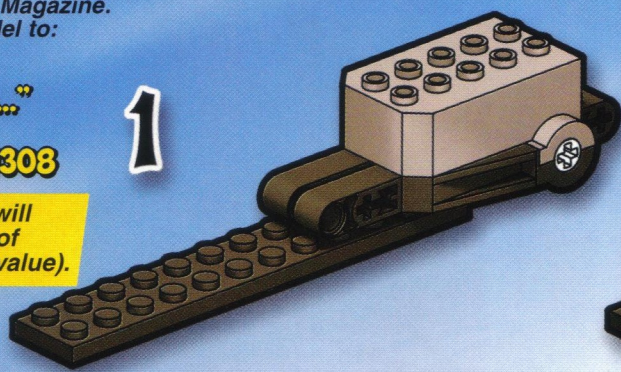

Pull back the Sonic Blaster Buggy and watch it race across the floor!

Use pieces from your own LEGO collection or you can find all the pieces you need to build the Sonic Blaster Buggy in #6714 Speed Dragster and #6519 Turbo Tiger.

OR
THIS!

GALACTIC HAWK



Club member Matthew Hills, age 15 of Arizona, inspired our model designers to build the Galactic Hawk.

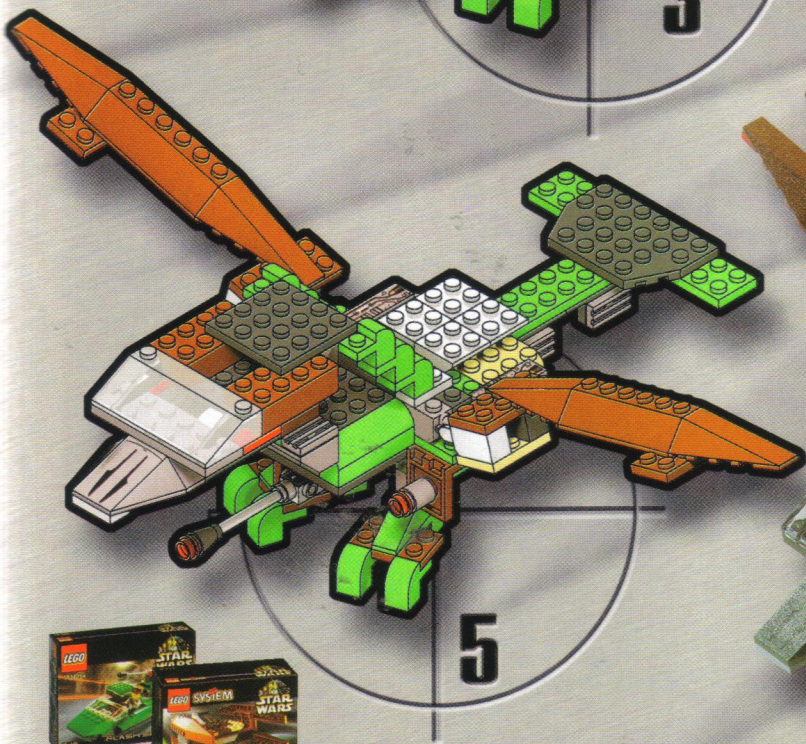
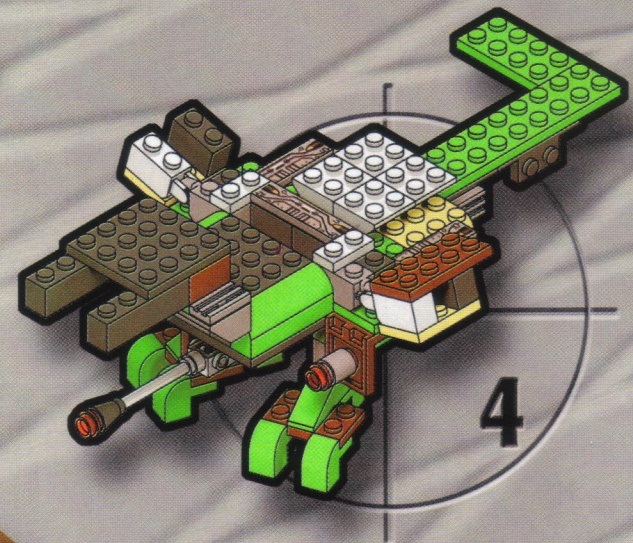
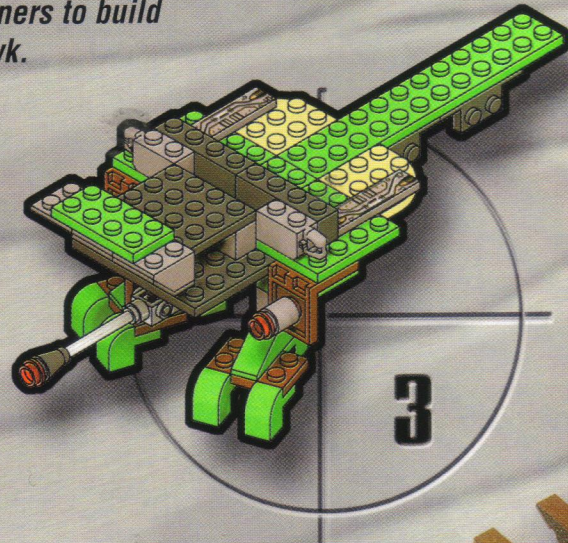
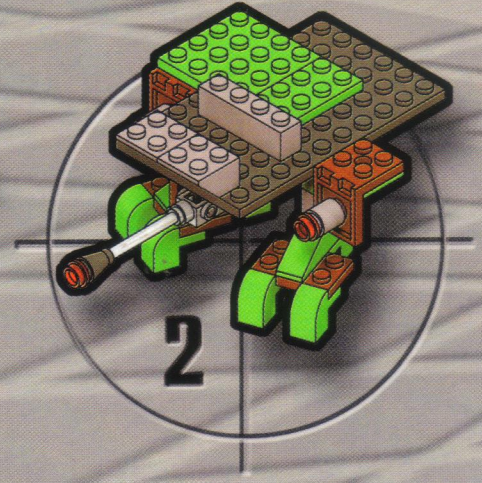
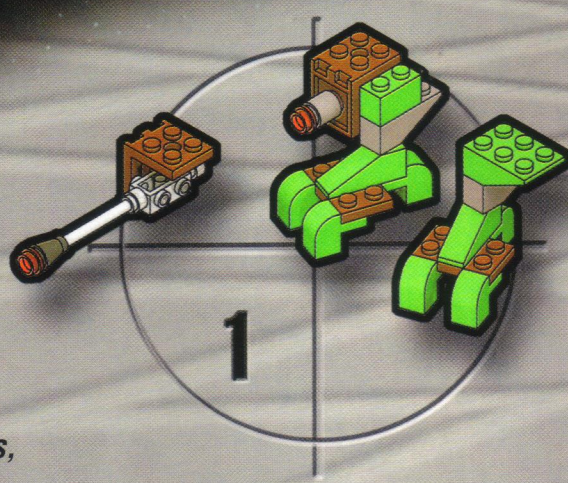

Use pieces from your own LEGO collection or you can find all the pieces you need to build the Galactic Hawk in #7124 Flash Speeder™ and #7111 Droid Fighter™.



For complete building steps for this model visit:
www.LEGO.com/ubuildit

Official Star Wars elements are property of Lucasfilm Ltd. and/or Lucas Licensing Ltd. All rights reserved. All Star Wars elements are property of Lucasfilm Ltd. and/or Lucas Licensing Ltd. © 2005 Lucasfilm Ltd. www.starwarskids.com

LEGO Alpha Team

TOP SECRET REPORT



Five members of Alpha Team left on a mission to infiltrate Ogel's headquarters - but none returned. With the team nabbed and their equipment scattered, they need your help!

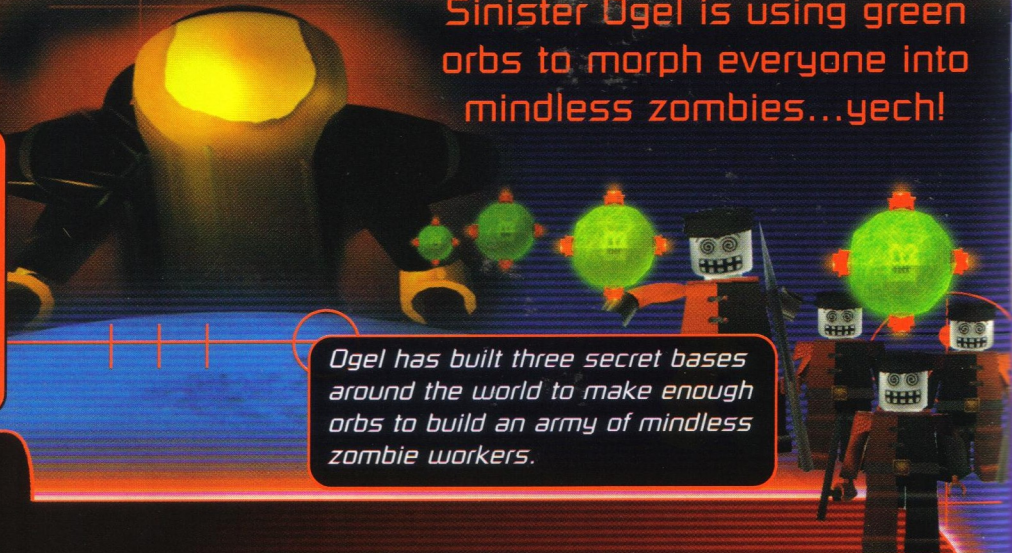

Sinister Ogel is using green orbs to morph everyone into mindless zombies...yech!

Ogel has built three secret bases around the world to make enough orbs to build an army of mindless zombie workers.

YOUR MISSION

Dash - motion expert and unshaven hero- is the only member of Alpha Team left uncaptured. He needs your help to free the team!



Infiltrate Ogel's hidden bases..



...locate your team members and their lost stuff...



...then stop production of those rotten green orbs!

The fate of the world in your hands. (Yikes!)





LEGO Stunt Rally

Race to the finish on your own custom made stunt track!



Mr. X marks the spot. He also gives you help when you need it!

Build zany tracks and race radical cars on four different worlds. Unlock new worlds by winning races!



Blast by the competition with powerful car upgrades.



Use wacky track pieces like this giant fan for awesome stunts!



Drive fast and win to unlock secret track pieces.



**Welcome to
the DANGER
ZONE!**



8512 **ONYX**

Onyx works best on rock faces, stony surfaces and mountain tops way above the tree line. When it gets too dark to see danger looming, he uses his laser blasters and keeps on going!



8513 **DUST**

A desert devil that turns his tracks into quicksand. The sand is no match for Dust - he flies across any terrain with super suspension.

8514 **POWER**

Power is built to move across any surface. With his adjustable robot arm and brakes, Power really pushes it to the limit and never loses a battle.



LEGO **TECHNIC**

ROBORIDERS



8510

LAVA

Lava loves doing battle with fiery volcanoes, even when the lava is molten and the sky is black with ash! Lava rocks in the way? No problem, Lava uses his dual axes to chop his way through.

8511

FROST

Studded tires carry this ROBORIDER across frosty landscapes covered in sharp icicles. Ice flow in the way? Frost uses his ice spears to pick his way out of danger.



8509

SWAMP

Without Swamp, you'd never make it through the murky gases of the swamp. Not even a swamp creature can get in his way- he just uses his dual swords to fight his way out.



**WEB
XTRAS!**

Visit www.LEGO.com/roboriders to play 6 different ROBORIDER games! Look for the secret code on the ROBORIDER can. Stick the can in the fridge to reveal each secret code.

LEGO MINDSTORMS™

STAR WARS™

Walking Robots at Your Command!

Build these Star Wars creations or use the Force to create your own!



Trade Federation AAT



Destroyer Droid

Used under authorization. ©Lucasfilm Ltd. & TM. All rights reserved. Official Star Wars Web Sites: www.starwars.com and www.starwarskids.com



The Dark Side is under your control with the LEGO MINDSTORMS Dark Side™ Developer Kit. Create a Destroyer Droid that charges forward. Construct an All Terrain Armored Transport (AT-AT) that strides on four legs. You can bring these robots and hundreds more Star Wars inspired creations to life.

The MicroScout, a LEGO microcomputer, powers your robots. It features a built-in motor, built in light sensor that gives your robot the ability to respond to light, and seven pre-set programs to make your robot move forward, backward and more. The possibilities are endless!

AT-AT really moves! Visit www.legomindstorms.com/darkside to see an animated scene of the AT-AT from *The Empire Strikes Back*

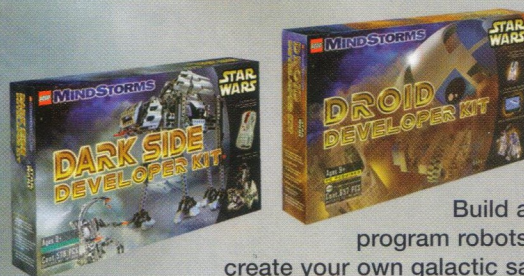

Build and program robots to create your own galactic saga by combining 9748 Droid Developer Kit and 9754 Dark Side Developer Kit. Good fights evil but the outcome is under your control!

T-Rex Trouble

ALEXIA SINISTER HAS GOTTEN HERSELF INTO A REAL PUZZLE. CUT OUT THE SQUARES AND REARRANGE THEM INTO A PICTURE. HOW WILL ALEXIA GET HERSELF OUT OF THIS?

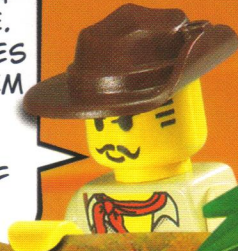

YUMMY
HERE COME
LUNCH

WHOA!
YOU NEED SOME
MOUTHWASH!

E

!MES
!



BUILD N' SCORE EVENT



WHEN: September 30, 2000
TIME: 10am - 2pm
WHERE: Your local Wal-Mart

Come to your local Wal-Mart and test your LEGO Soccer shooting skills. You'll have 60 seconds to build a LEGO Soccer Field and score as many goals as possible.

Each person will receive a certificate of achievement and an activity book filled with Soccer trivia and fun activities!



FREE GIFTS TO THE FIRST 100 PARTICIPANTS*
* Ages 5-15

Come build and play with the **NEW LEGO Soccer LINE!**

No one can resist a Sunkist® Orange!

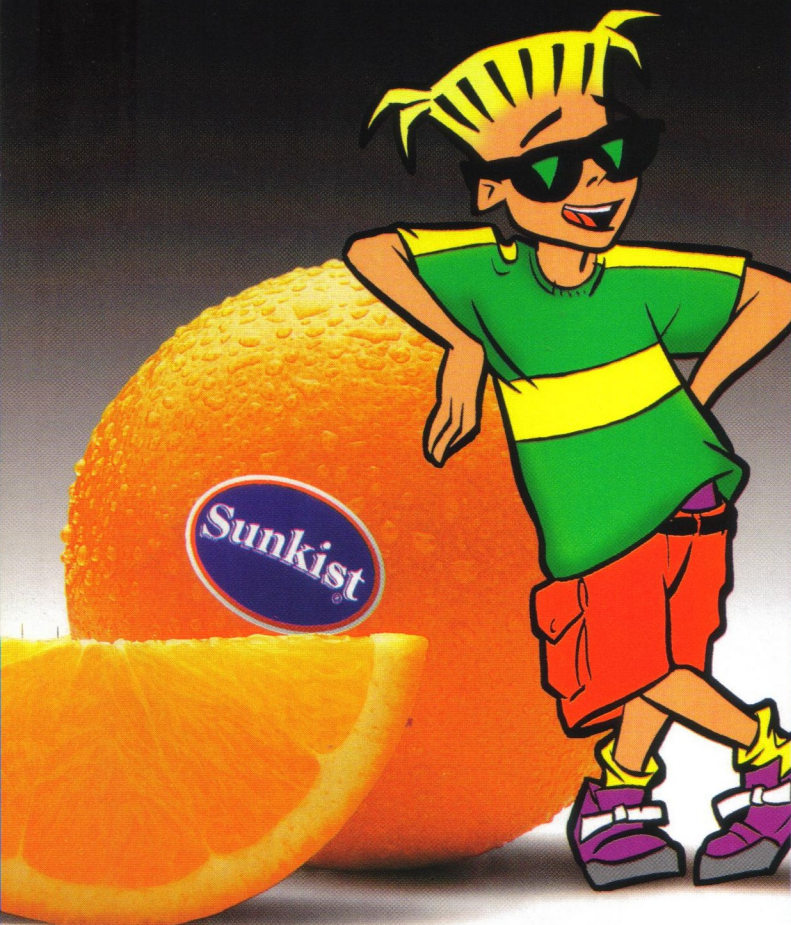

ORTEGA



YOU CAN BUILD THIS..



Build a Better Taco with Ortega!

www.ortega.com

©Nestlé The LEGO Maniac is a trademark of the LEGO Group. ©2000 the LEGO Group.

The LEGO Maniac is a trademark of the LEGO Group. ©2000 The LEGO Group.

www.sunkist.com

Sunkist, Sunkist and "No one can resist a Sunkist Orange" are trademarks of Sunkist Growers, Inc. ©2000 Sunkist Growers, Inc.

Create a Watch as Unique as you are!

Mix and match brightly colored links, straps and bezels to create hundreds of different styles from just one watch!



Glow in the dark dial.



Program your own digital message



LEGO TIME

Are you ready for a REAL adventure?



Enjoy a child size popcorn, a child size fountain soda and receive one LEGO Adventurers collector's toy!

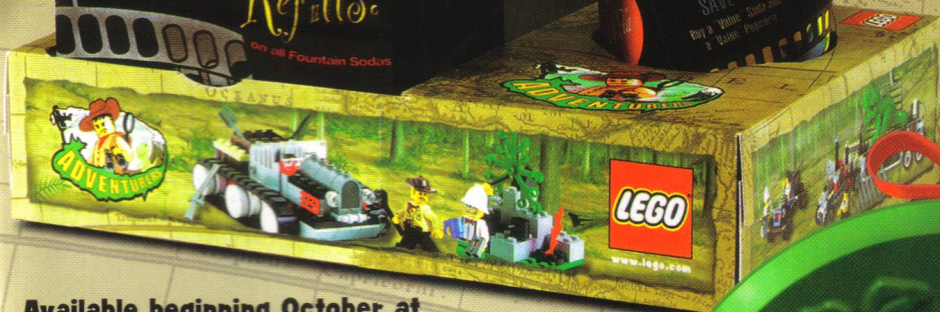

Johnny Thunder Canteen (w/ flying disk)

Available beginning October at



LOEWS
CINEPLEX

ENTERTAINMENT

Available while supplies last. Children 12 & under only.

COLLECT
ALL 3!



www.enjoytheshow.com



Dino Light

Wrist Compass

Count the Dinos Contest

There are dinosaurs roaming all over pages 12 and 13. Help Johnny Thunder and the Adventurers count the dinos and you could capture the LEGO® set of your choice! All dinosaurs count - even the baby T-Rex and the flying dinos.

You could win a LEGO Set like this!



Go to pages 12-13 and start counting!

Entries must be postmarked by November 17, 2000 and received by November 22, 2000. Winners will be notified by mail by December 28, 2000. Offer void where prohibited or restricted by law. Employees of The LEGO Group and their immediate families are not eligible to participate. Entries will be judged by LEGO Systems, Inc. on the basis of accuracy.

LEGO, the LEGO logo, LEGO Mania, the LEGO Maniac, the LEGO TECHNIC logo, LEGOLAND, the LEGOLAND logo, and Mindstorms are trademarks of The LEGO Group. ©2000 The LEGO Group.

The first 10 randomly selected, entries with the correct answer will win a LEGO set of their choice (up to a \$100 value).

How to Enter:

Just fill in the Contest Entry Form, cut it out and mail it by November 17, 2000 to:

Count the Dinos Contest
LEGO Mania Magazine
 P.O. Box 1625
 Enfield, CT 06083-1625

Presorted Standard
 U.S. Postage
 PAID
 LEGO Direct

Count the Dinos Contest Entry Form

I found _____ dinosaurs on pages 12-13 of this magazine.

Date of Birth: Month _____ Day _____ Year _____

ADDRESS SERVICE REQUESTED

Visit us on-line at the ALL NEW www.LEGO.com

- Visit the new "Adventures" area to enter the On-line story contest.
- See an animated LEGO Mindstorms recreation of the AT-AT Walker scene from *The Empire Strikes Back* at www.legomindstorms.com/darkside
- The LEGO Mindstorms Mall Tour may be visiting a city near you! For a complete tour schedule visit www.legomindstorms.com

LEGO wishes come true...

Now you can make your LEGO Wish List and your parents can buy on-line! You'll find many of your favorite sets and some hard-to-find sets, including Bulk Paks, LEGO Technic Power Packs and more.